

GLF77XE

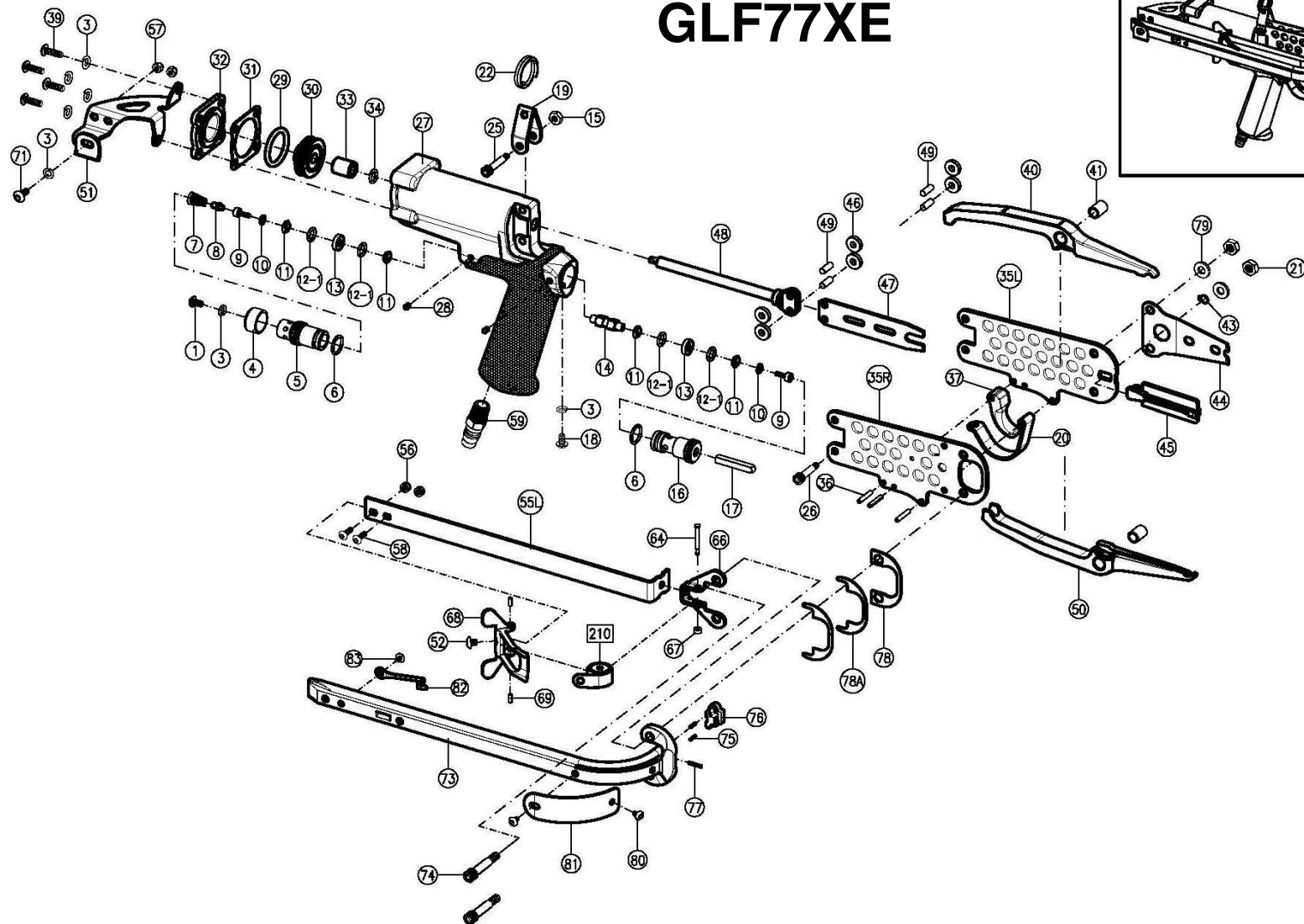

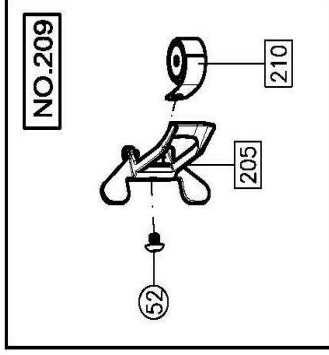
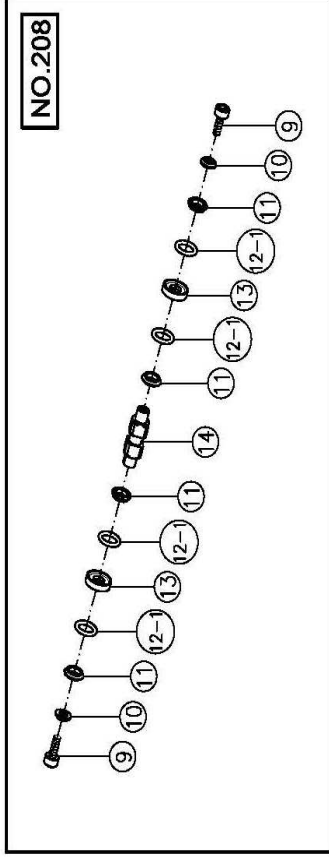
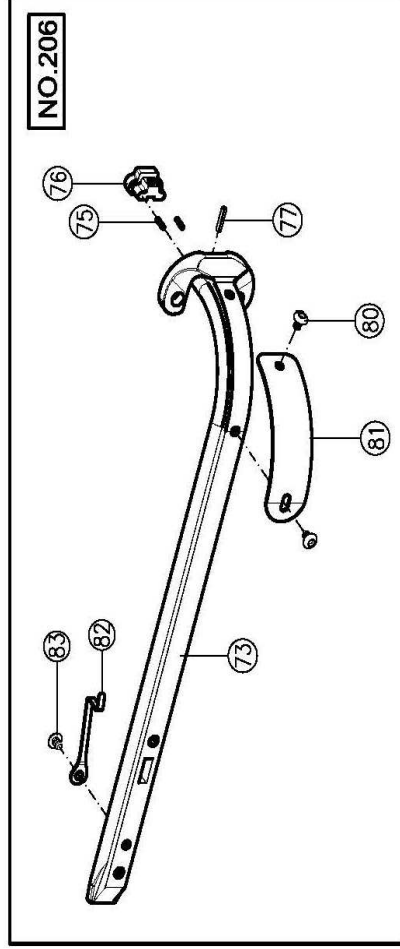
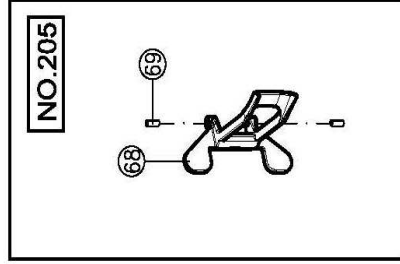
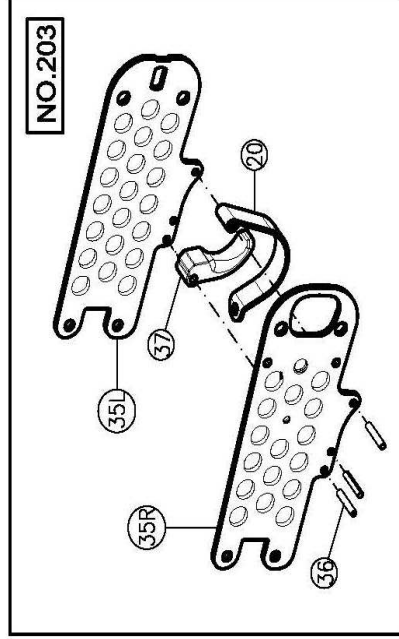
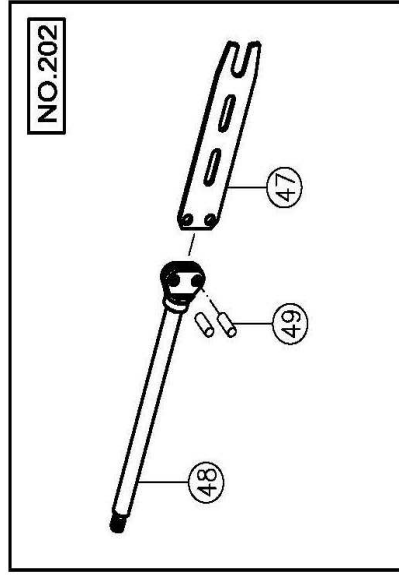
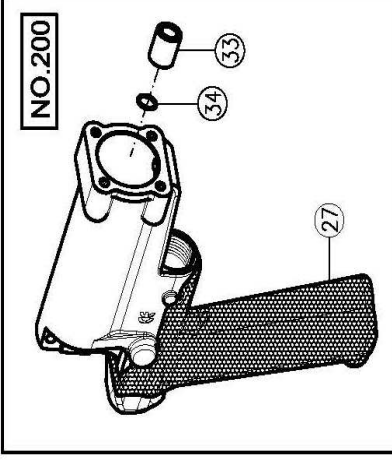
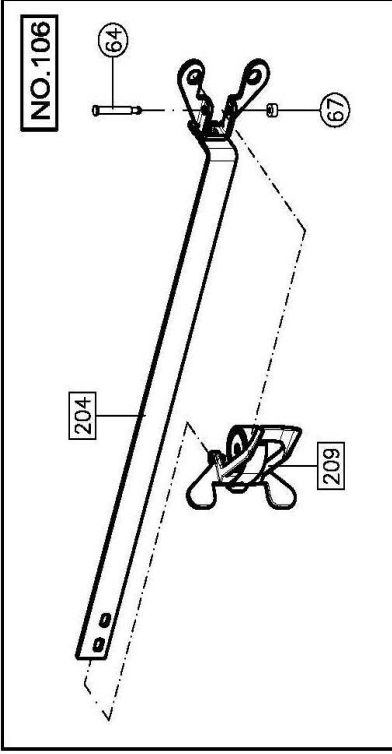

PARTS LIST FOR Model GLF77XE

ITEM	DESCRIPTION	PART NO.	Q'TY	ITEM	DESCRIPTION	PART NO.	Q'TY	ITEM	DESCRIPTION	PART NO.	Q'TY
1	Set Screw	01001	1	32	Piston Stop Spacer	21032	1	68	Pusher	23N068	1
3	Shakeproof lock Washer	01003	7	33	Bushing	11033	1	69	Stop Ring	01069	2
4	Air Deflector	01004	1	34	O-Ring	01051-NP	1	71	Screw	11071	1
5	Rear Valve Seat	01005	1	35R	Side Plate (Right)	2135R	1	73	Magazine Body	02M073	1
6	O-Ring	01006	2	35L	Side Plate (Left)	2135L	1	74	Jaw Bolt	01074	2
7	Throttle Spring	01007	1	36	Pin	01036	3	75	Magazine Spring	02075	2
8	Throttle Spring Locator	01008	1	37	Trigger	01037	1	76	Magazine Shoe	02M076	1
9	Throttle Valve Screw	01009	2	39	Set Screw	21039	4	77	Roll Pin	02077	1
10	Valve Screw Washer	01010	2	40	Upper Jaw	23040	1	78	Magazine Shim	01078	1
11	O-Ring Support	01011	4	41	Jaw Bushing	01041	2	78A	Magazine Shim	0178A	2
12	O-Ring	01012-1-NP	4	43	Latch Pin Clip	01043	1	79	Washer	01079	2
13	O-Ring Center Support	01013	2	44	Latch Spring	21044	1	80	Screw	02080-1	2
14	Throttle Valve Spacer	01014	1	45	Latch	21045	1	81	Guard	02081	1
15	Nut	11015	1	46	Roller	01046	4	82	Clip Anti-Backup	02082	1
16	Front Valve Seat	01016	1	47	Feeder Blade	22047	1	83	Screw	01M083	1
17	Throttle Stem	01017	1	48	Piston Rod	21048	1	86	Washer	01M086	1
18	Bottom Head Cap Screw	01018	1	49	Roller Pin	01049	2	106	Feeder Guid Rail Assy.	23N106	1
19	V Hanger	11019	1	50	Lower Jaw	23050	1	200	Housing Assy.	21MC200	1
20	Trigger Guard	01020	1	51	Feeder Arm	21M051	1	202	Piston Rod Assy.	22202	1
21	Flexloc Nut	01021	2	52	Screw	11052	1	203	Side Plate Assy.	21203	1
22	Hanger Ring	11022	1	55L	Feeder Guid Rail	23N55L	1	204	Feeder Guid Rail Assy.	23N204	1
25	Set Screw	11025	1	56	Nut	11056	2	205	Pusher Assy.	23N205	1
26	Screw	11026	2	57	Nut	11057	2	206	Magazine Assy.	02A206	1
27	Housing	21MC027	1	58	Screw	11058	2	208	Throttle Assy.	01208	1
28	Set Screw	01028	2	59	Inlet Bushing	01059	1	209	Pusher Spring Assy.	23N209	1
29	O-Ring	21029	1	64	Pusher Pin	01M094A	1				
30	Piston	21030	1	66	Feeder Guide Rail set	23N066	1	210	Spring Assy.	01M210	1
31	Cylinder Gasket	21031	1	67	Stop Ring	01059	1				